

resus

Application guideline 2.1

Look forward.

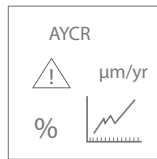
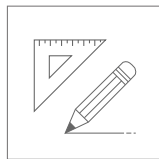
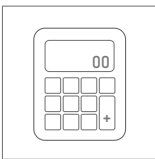
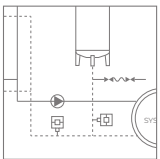
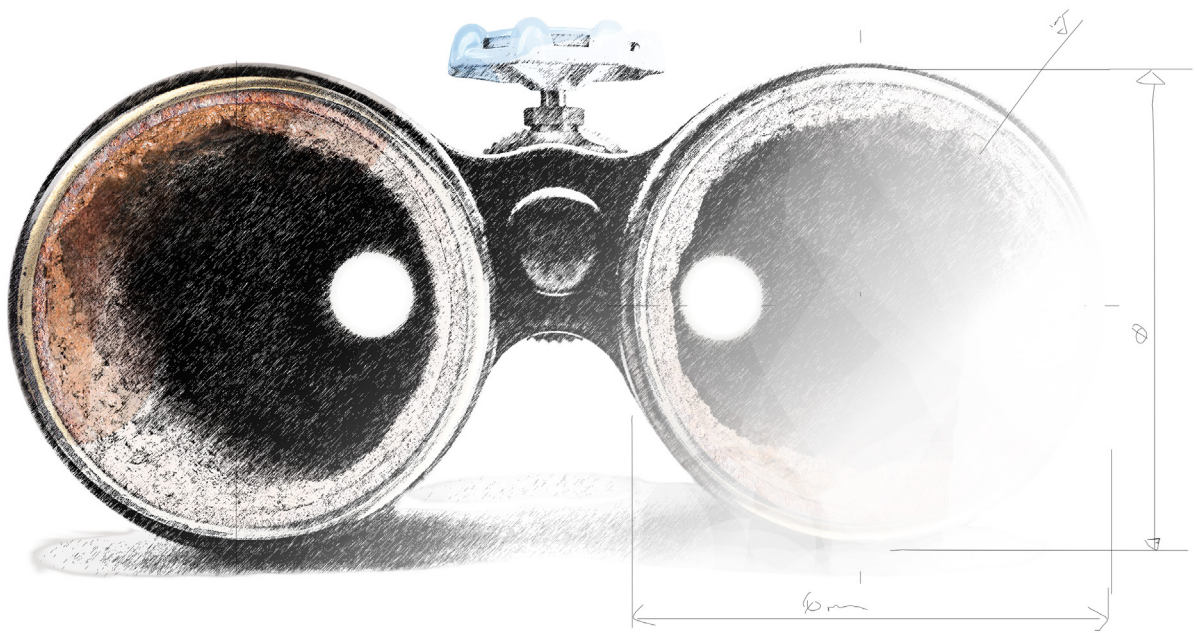

Guideline for the responsible application of corrosion monitoring in heating systems and water-based cooling systems.

TABLE OF CONTENTS

1 INTRODUCTION	4
1.1 RESUS	4
1.2 SYMBOLS	5
1.3 TERMS	6
1.3.1 The robust system	6
1.3.2 Predictive maintenance	7
1.3.3 Water quality	7
1.3.4 Corrosion	8
1.3.5 Measuring is knowing	9
2 PLANNING CORROSION MONITORING	10
2.1 MINIMUM	10
2.1.1 Small systems <70 kW	10
2.1.2 Large systems >70 kW	11
2.1.3 Very large systems	11
2.2 OPTIMUM	12
2.2.1 Risk circuits	12
2.2.2 Risk components	13
2.3 IDEAL	14
2.3.1 Main circuits and groups	14
2.3.2 Heat and cold generators	14
2.3.3 Budget-friendly ideal	15
2.4 OFFICIAL GUIDELINES	16
2.4.1 Belgium	16
2.4.2 The Netherlands	17
2.4.3 The United Kingdom	18
2.4.4 Germany	19

3 WORKING WITH RISYCOR	20
3.1 ALARM MESSAGES	20
3.2 MEMORY READ-OUT: RESUS DASHBOARDS	21
3.3 INTERPRETING THE MEASUREMENTS	23
3.4 CONNECTING TO A BUILDING MANAGEMENT SYSTEM	24
3.4.1 Low or high alarm	24
3.4.2 Average yearly corrosion rate AYCR	25
3.5 OTHER FORMS OF REMOTE SIGNALLING	26
3.6 ADDITIONAL BENEFIT: TEMPERATURE MONITORING	26
4 CAUSES OF CORROSION DAMAGE AND FAILURE	27
4.1 RISYBASICS	27
4.2 RISYCARDS	28
5 ABOUT RISYCOR	30
5.1 OPERATING PRINCIPLE	30
5.2 SERVICE LIFE	31
5.3 LIMITATIONS	31
5.3.1 Inhibitors and glycol	31
5.3.2 Early installation of the probe	32
5.3.3 In the return	32
5.4 REPRESENTATIVENESS	32
5.5 CURATIVE USE IN PROBLEM SYSTEMS	33
5.6 TROUBLESHOOTING	33
5.7 PRODUCTS	34
5.7.1 X-family: universal mounting	34
5.7.2 B-family: bayonet mounting	35

1. INTRODUCTION

1.1 RESUS

Resus is the abbreviation for the terms RELiable and SUStainable. Heating systems need to be both reliable and durable, and thus operate without fault for as long as possible. This is circularity in its purest form – not recycling, but retaining, see TT33. But as some influencing factors have the capability to cause unwanted deterioration, monitoring is essential. But why should a radiator or a pipe ‘wear out’? If there’s no dirt, rust or limescale, a tap, a valve, a collector or other part of a heating system need not break down, right?

Thirty years of experience in preventing oxygen ingress through proper pressure maintenance led to the development of an accurate, reliable and low-cost corrosion monitoring method. More than ten years later, Risycors now monitor thousands of systems and in many hundreds of them, have uncovered hidden problems without any significant investment, resulting in unquantifiable savings.

In the past, there was no need for monitoring on account of the lower risk and because appropriate monitoring technologies were not available. However monitoring has become essential in today’s heating and chilled water systems, and today the technology is available. Predictive maintenance based on monitoring with Risycor is always more cost-effective and more efficient than preventive or curative maintenance. As such, it is important to prevent corrosion-related problems from occurring by ensuring early warning and providing effective continuous monitoring in every design (see below).



In the same way that a smoke detector ensures early warning of fire, the Risycor prevents expensive and damaging corrosion. Early warning in this way is our contribution to extending service life, a uniquely circular way of thinking. No other component in a heating or cooling system offers such a ratio of low cost to high cost savings potential, and it’s time for the industry to accept and apply this. Will you join in and contribute as well?

Thank you in advance.
Karl Willemen





1.2 SYMBOLS



CORROSION MONITORS





-  Risycor CX with X-fix
-  Risycor CBU with Zerofix
-  Risyttest TXV with X-fix

MISCELLANEOUS

-  Circuit up to the highest point
-  Diffusion through non-oxygen-tight plastic or rubber

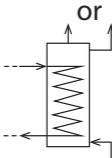
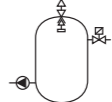
COMPONENTS

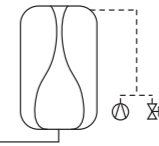
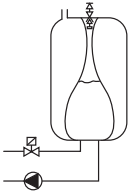
-  Boiler or heat generator
-  Circulation pump
-  Water make-up that can add (oxygen-rich) mains water to the installation

-  Domestic hot water generation
-  Pressure step (or vacuum-) degasser
-  Expansion vessel with membrane
-  Expansion vessel with bladder
-  Expansion system with compressor
-  Expansion system with pump and degassing in the bladder
-  Blanking plug

1.3 TERMS

1.3.1 THE ROBUST SYSTEM

The robust system is the result of sound design, correct commissioning, operation, maintenance and control. Unfortunately, some corrosion is unavoidable, but the good news is that the corrosion process can be stopped by eliminating oxygen ingress. De-oxygenated water will prevent any corrosion damage. De-oxygenated water defines a closed system and prevents corrosion damage. Contrary to what many believe, this can be easily achieved and has been proven in millions of systems for many decades.

The 'robust system' is a system that, during its intended service life is not impaired by corrosion or sludge related problems. E.g. a loss of efficiency, leakages, blockages or premature component failures.

You can 'hope and keep your fingers crossed' that things will always go well, or instead rely on a monitoring system - trust is one thing, but control is better.

Specifically, this means that a corrosion sealed system has proper pressure maintenance (expansion vessel/expansion system). In practice, more than 90 per cent of systems with corrosion related problems do not work properly in this regard. (see 4. Causes of corrosion damage and failure).

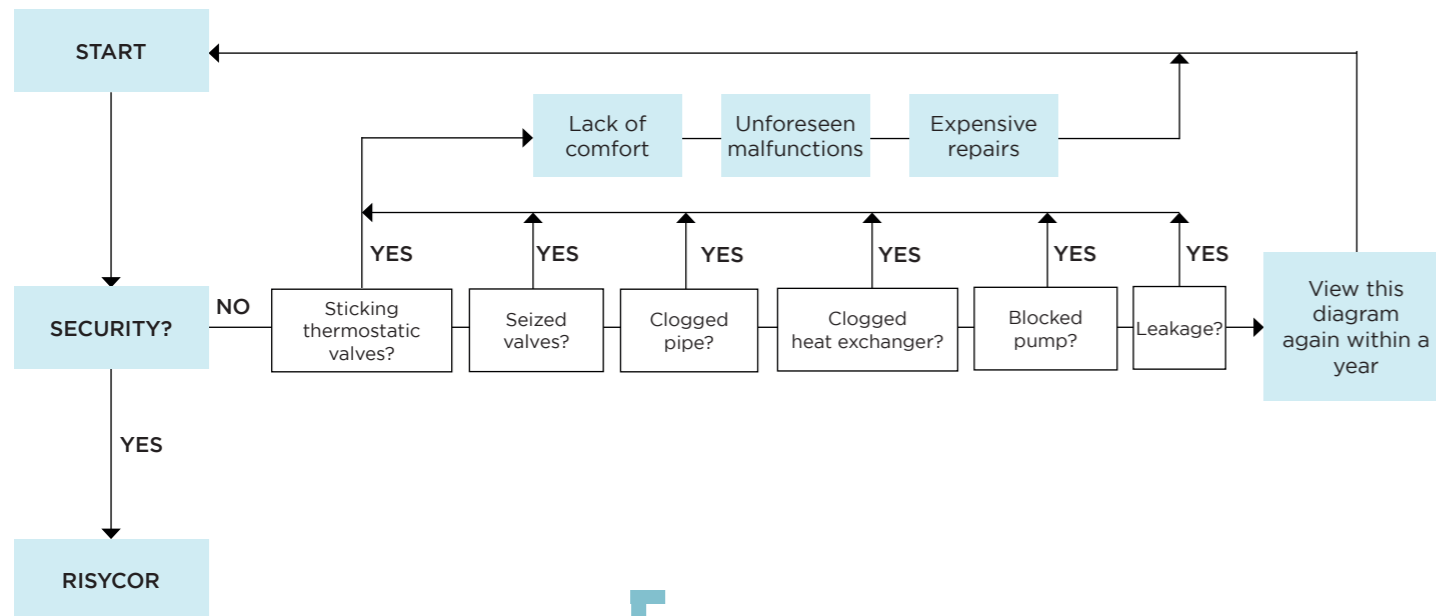

Only continuous monitoring can protect systems from corrosion damage.

1.3.2 PREDICTIVE MAINTENANCE

With permanent and smart measurement, predictive maintenance prevents (predictably) problems from occurring, and thus prevents inconvenience and unnecessary costs. Corrosion monitoring in water-based central heating and cooling systems can help to achieve significant savings and prevent damage by detecting abnormalities early on. The Risycor is a very simple, accurate and affordable corrosion monitoring system that can be used in much the same way smoke detectors are used for fire protection:

smoke detectors do not prevent fire, but they do raise the alarm in good time.

- One smoke detector alone offers only minimal protection,
- but several smoke detectors at critical locations provide optimal protection.
- A smoke detector in every room is ideal.

The Risycor does not prevent corrosion, but it does raise the alarm in good time, thus helping to prevent unnecessary faults and expenses in the long term. Depending on the security scenario desired, and the budget available, you can achieve security in three scenarios:

- **Minimum:** one Risycor in the main return
- **Optimum:** as well as the above, a Risycor at the output of risk circuits and risk components
- **Ideal:** as well as the above, a Risycor in the return of each main circuit

1.3.3 WATER QUALITY

The term 'water quality' is often used and suggests that corrosion is related to the quality of the water. In reality, corrosion damage tends to be caused by conditions affecting the water.

To prevent corrosion damage, it is important that we look at systemic aspects instead of focusing on water quality. De-oxygenated water is the result of the right conditions, systemic choices, proper commissioning, operation, maintenance and monitoring.

By the way

- water analysis does not offer protection against corrosion damage (see TT20 and TT28).
- Water treatment cannot compensate for physical (systemic) deficiencies.

1.3.4 CORROSION

- **Corrosion** is the electrochemical reaction by which metal oxidises with the aid of oxygen and forms metal oxides that can cause unwanted sludge formation in a heating system.
- **Corrosion damage** is the result of corrosion that causes a reduction in the functionality of a material, its environment or the technical system of which the material is a part (e.g. due to sludge deposits).
- **Corrosion failure** means the loss of the functionality of a component or of the system as a whole (e.g. blockage or leakage).
- **Damage pattern** is the observable expression of corrosion damage and/or failure, such as 'blocked' thermostat valves, jammed circulation pumps, clogged heat exchangers or leakage.

For RESUS, the most important aspect is early warning of corrosion, so that corrosion damage can be avoided and corrosion failure eliminated. The Risycor ensures that no damage ever occurs.

There are various different forms of corrosion, only a few of which occur in water-based heating and cooling systems. Experience and research have shown that in these systems, 'uniform' oxygen corrosion is the most common, under the influence of (unwanted) oxygen ingress. Other forms of corrosion are more exceptional (unless the system has been treated with anti-corrosion inhibitors, in which case other forms of corrosion can thrive under certain conditions). See also *4. Causes of corrosion damage and failure*

1.3.5 MEASURING IS KNOWING

The corrosion rate can be expressed in a number of ways. The most common expression is the 'yearly corrosion rate'

YCR

which is the corrosion rate expressed in $\mu\text{m}/\text{yr}$ (micrometres per year). It shows the decrease in mass of the coupon at the tip of the Risycor. YCR is an instantaneous/actual value, which varies with the ingress of oxygen (similar to speed in km/h).

AYCR

The AYCR (Average Yearly Corrosion Rate) is a useful parameter for tracking the reliability and service life of a system to prevent corrosion damage due to sludge formation over a more prolonged period – perhaps several months or a year. AYCR in $\mu\text{m}/\text{yr}$ can be compared with the average speed over a certain distance. In imperial measuring systems, mpy (mil per year: 1 mil = inch/1000) is sometimes used, where 1 mpy = 25.4 $\mu\text{m}/\text{yr}$.

As stated above, analytical measurements of system water parameters are typically much less important than is generally assumed. As an example, dissolved metal ions content, pH and conductivity and even dissolved oxygen are seldom relevant in the context of a system's service life and reliability – logging the corrosion rate, however, is (see below and TT20).

2. PLANNING CORROSION MONITORING

2.1 MINIMUM

Minimum security covers the risk of corrosion damage using the cheapest method possible - comparable to one smoke detector for an entire building .

2.1.1 SMALL SYSTEMS ≤70 KW

One Risycor in the main return, through which the complete flow of the system passes.

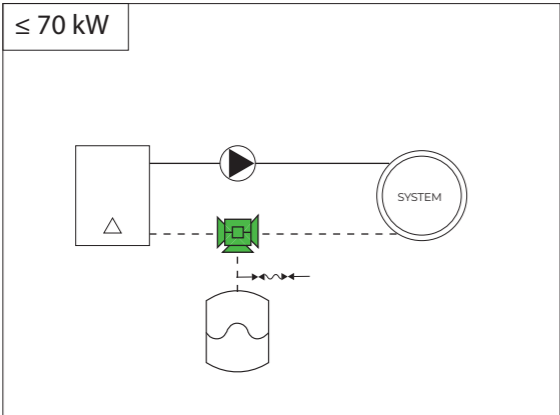

2.1.2 LARGE SYSTEMS >70 KW

One Risycor in the main return, through which the complete flow of the system passes, and one Risycor in the expansion line, where the system is also refilled.

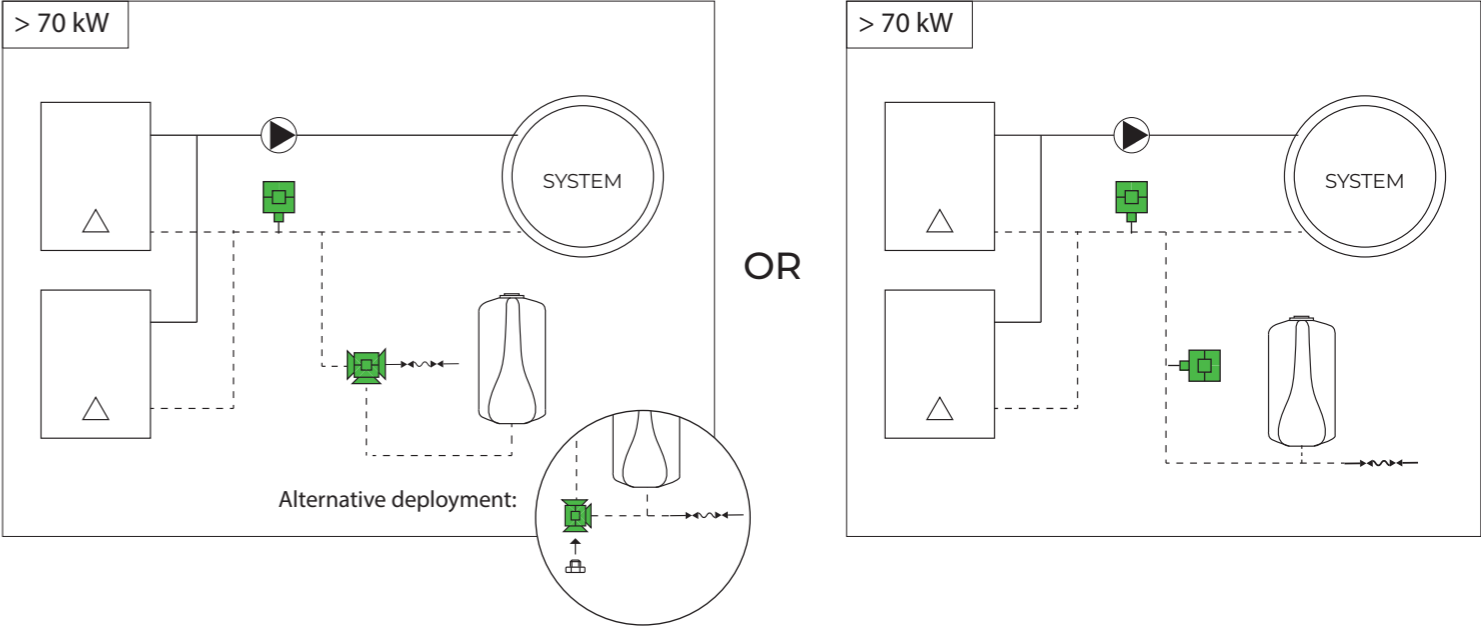

2.1.3 VERY LARGE SYSTEMS

In very large systems, a Risycor is fitted in the return of every sub-station.



2.2 OPTIMUM

Optimum security is the best compromise between the potential costs of corrosion damage and the cost of receiving an early warning. This scenario also makes possible identification of the cause much more straightforward.

In addition to minimum protection, this scenario provides for Risycors at high-risk locations as explained below.

2.2.1 RISK CIRCUITS

Risk circuits are those with a risk of oxygen ingress:

- In a circuit with non-diffusion-tight (plastic or rubber) hoses (e.g. cold beams or climates ceilings, fan coils connected with rubber flexibles)
- In a high circuit (in case of poor pressure maintenance)

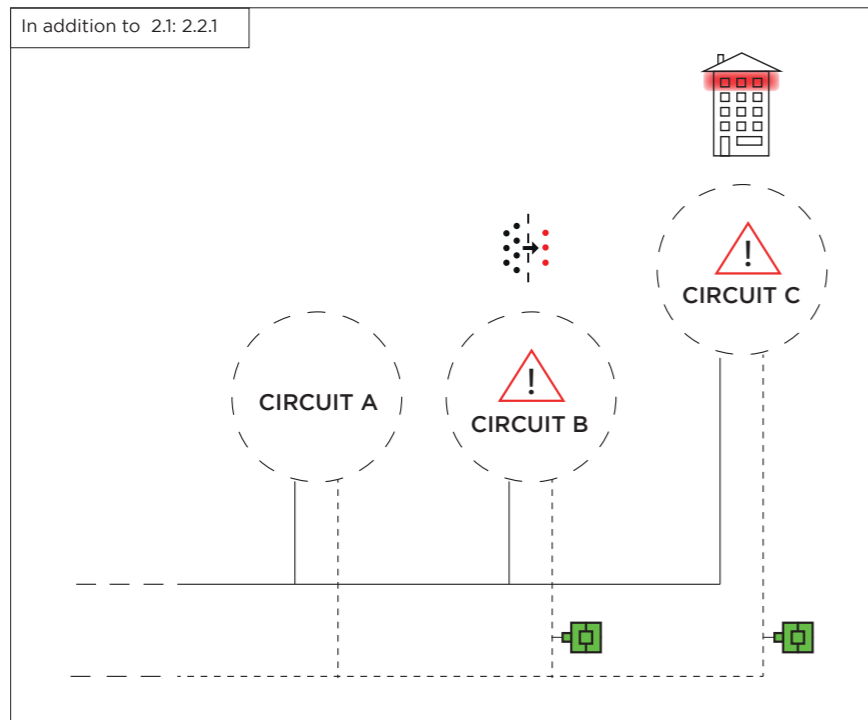

2.2.2 RISK COMPONENTS

Risk components are devices, appliances or elements with an elevated risk of oxygen ingress:

1. Pressure step- (or vacuum) degassers (RICA 04)
2. Expansion systems with degassing in the bladder (RICA 04 and 05)
3. Expansion systems with compressors (RICA 05)
4. Domestic hot water generators (heat exchangers, boilers, etc.) (RICA 06).

Our Risycard information sheets outline each risk in detail

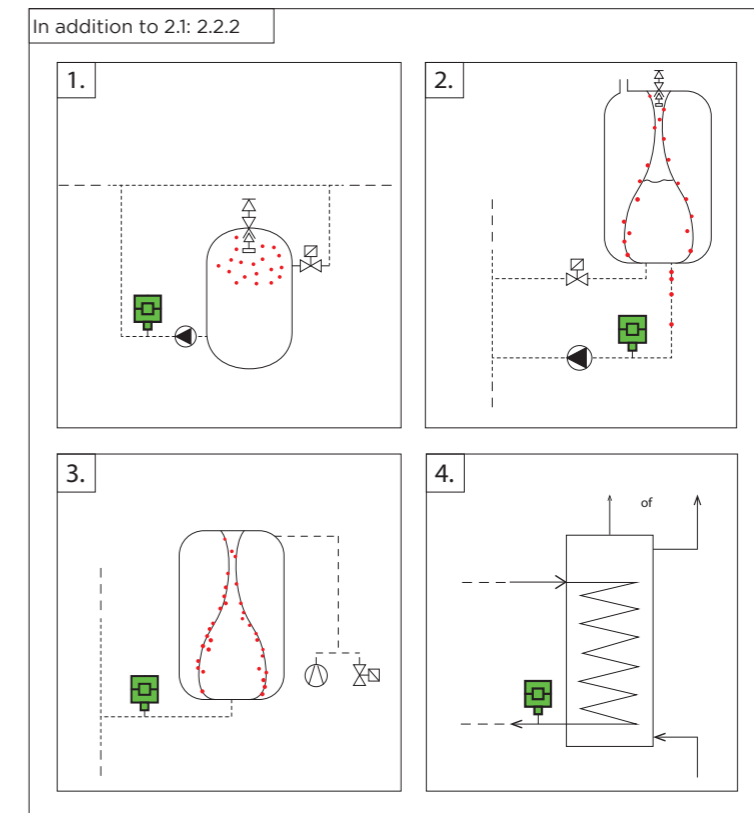

2.3 IDEAL

Ideal security meets the wishes or needs of end users in terms of service life, freedom from faults, ROI and TCO.

It also helps with possible identification of the cause.

In addition to minimum and optimum protection, this scenario provides for Risycors at important locations as explained below.

2.3.1 MAIN CIRCUITS AND GROUPS

The fitting of Risycors in the return of each main circuit or group of heat consumers provides valuable additional insight into the corrosion behaviour of the system and the relationship of the circuits and groups of consumers to one another.

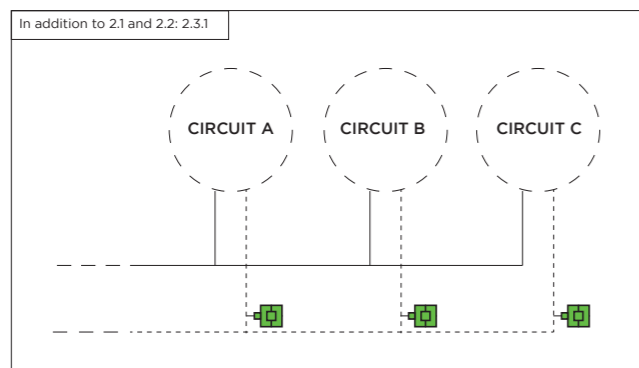

2.3.2 HEAT AND COLD GENERATORS

Manufacturers of boilers, heat pumps and chillers may demand additional safety due to warranty conditions, the desire for improved operational safety, to cover themselves against misuse or human error, etc. In that case, fitting a Risycor in the return of each generator makes sense, as it accurately logs the corrosion rate at the inlet of the boiler, heat pump, CHP, chiller, etc.

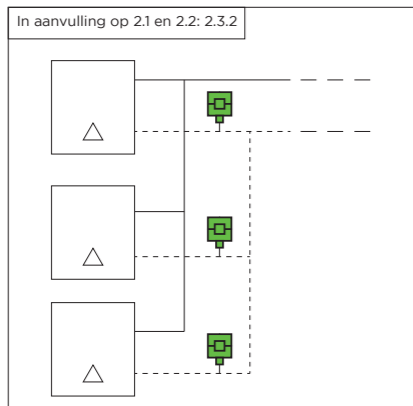

2.3.3 BUDGET-FRIENDLY IDEAL

In terms of budgets for investment and maintenance, the lower the investment, the more likely the maintenance costs are to be higher. It is widely acknowledged that the frustration of low quality lasts for longer than the joy of a low price. At the same time, however, expensive does not always mean better.

Resus has conceived a budget-friendly alternative for the ideal scenario, by equipping the additional monitoring points that come on top of the optimal scenario with the cheaper Risyttest instead of Risycors. In the event that corrosion problems do occur, the Risyttest probes can be visually inspected to indicate the exact location of the corrosion risk, and can be easily exchanged for real Risycor monitors, if necessary. After all, X-fix installation is already provided for in the Risyttest, so exchange during operation is possible using the Retractor - see TD Risyttest. As the Risyttest has no alarm capability, this philosophy cannot be applied in the minimum or optimum security scenarios, unless the user decides beforehand to use Risyttest in order to keep the investment budget low, and then use the X-fix to conveniently mount Risycors on the maintenance budget later.

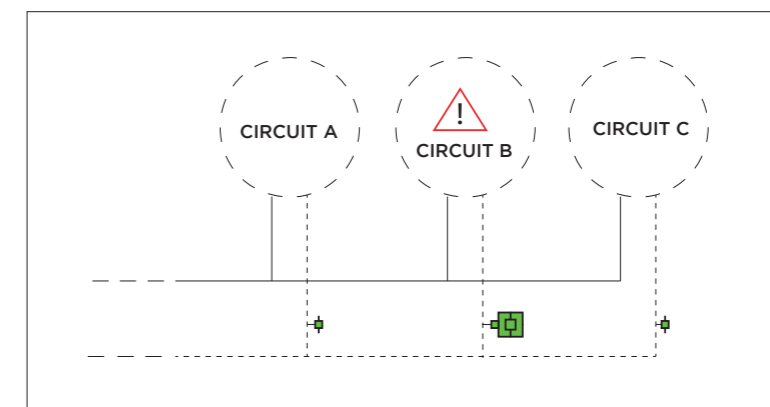

2.4 OFFICIAL GUIDELINES

In addition to the aforementioned 'RESUS' recommendations, many countries also have official guidelines governing corrosion monitoring. In most cases, the setup is similar to the scenarios outlined above. The following are some important details:

2.4.1 BELGIUM

WTCB technical information TV278: hot-water heating systems - recommendations for the prevention of deposits and corrosion

Contains a general recommendation that corrosion monitoring is highly recommended, particularly in more complex systems, as 'even when all the recommendations in this document are followed, the occurrence of corrosion during system operation can never be entirely ruled out.'

In addition, this guideline also lists many specific recommendations for providing for corrosion monitoring with an alarm function, e.g. for closed expansion systems with constant pressure (with compressor or with pump), for pressure-step deaerators, for chemical water treatment and as an aid for problem diagnosis:

TV278 7.2.4 ANALYSIS OF THE RESULTS OF CORROSION MONITORING **'Corrosion monitoring is the preferred tool when it comes to knowing whether or not there is corrosion in the system: determining the corrosion rate on the basis of coupons (Sec. 4.11.1, p. 21) or an electronic measurement (Sec. 4.11.2, p. 23) gives an immediate idea of the rate of the deterioration...'**

Federal Buildings Authority Type Specification 105 2022

This mandatory type specification applies throughout Belgium as a guideline for specifications for official buildings, and is very often referred to in private homes as well. In the as-yet unpublished revision for 2022, a mandatory text on corrosion monitoring will be included in Section C23.

Flemish Energy Company HVAC type specifications

Contains a section on corrosion monitoring in 16.1.



2.4.2 THE NETHERLANDS

ISSO publication 13: Preventing corrosion and soiling

This ISSO publication provides guidelines for programme, design and preparation phases for preventing corrosion and related soiling.

The existing monitoring methods are explained and the locations at which corrosion monitoring should be provided for.

ISSO 13 4.8.3 WHERE TO PROVIDE FOR MONITORING

'The degree of protection against corrosion is related to the number and quality of the monitoring units installed:

it is recommended that at least one corrosion rate monitoring unit be installed in the general return line of each system;

Incorporate additional options (optional) in those specific return lines where there is a potential risk of the ingress of oxygen. Consider:

- *Expansion line (risk of defective diaphragm/bladder). The replenishment line should ideally be connected to the expansion line in such a way that the corrosion monitoring unit also takes in the replenishment water;*
- *Return line from the highest point due to the risk of excess low pressure (oxygen ingress corrosion);*
- *Return line of each circuit containing non-oxygen-tight components, such as rubber hoses.*

Incorporate a corrosion rate monitoring unit with alarm function into the return line of risk-bearing components such as combination expansion systems and pressure-step deaerators.'



2.4.3 THE UNITED KINGDOM

BSRIA BG29/2021: Pre-Commission Cleaning of Pipework Systems

This publication quotes the benefit of corrosion coupons and explains that corrosion rate monitoring can be carried out accurately (see BG 29/2020 - 2.3.8: System facilities and 3.3.2 Inspection and witnessing on systems with corrosion monitoring).

BSRIA BG 50/2021: Water Treatment for Closed Heating and Cooling Systems

The benefits and importance of monitoring yearly corrosion rates are explained, as well as where corrosion sensors should be installed in the system (see 2.9: Corrosion coupons and probes and 2.9.3: Electronic coupon method). In Appendix A, this guideline specifically mentions the Risycor in case study 13

CIBSE Publication CP1 2020: Heat Networks: Code of Practice for the UK

This guide was published in 2020 by CIBSE to raise standards for heat networks in the UK and is a very significant update of the 2015 version. For the first time it refers to the German VDI2035 Part 1 as a chemical free alternative for corrosion control.

Furthermore, it recommends on page 151:

Best practice would be to:

BP6.3a systematically monitor corrosion in the system using the electronic coupon method

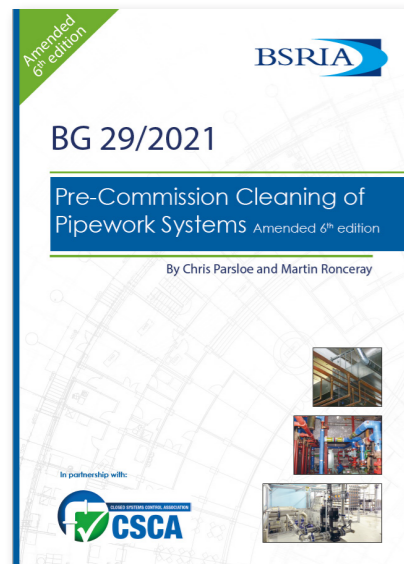

2.4.4 GERMANY

VDI6044: Avoidance of damage in cold water and cooling circuits

This guideline, published by Verein für Deutsche Ingenieure, treats corrosion monitoring as a quasi-necessity in 5.4.4. The Risycor is explicitly referred to in 5.4.4.3 under the title 'The electronic coupon method'.

VDI/BTGA-RICHTLINIEN		Februar 2022
VEREIN DEUTSCHER INGENIEURE BUNDEINDUSTRIE-VERBAND TECHNISCHE GERÄTEAUSRÜSTUNG	Vermidung von Schäden in Kaltwasser- und Kühlkreisläufen	VDI/BTGA 6044 Entwurf
Prevention of damage in cold and cooling water circuits		Eintritte bis 2022-05-31 • vorgewiesen über das VDI-Richtlinien-Eintragungspunkt WV-Nr. 10.0004
		• in Papierform an VDI-Gesellschaft Bauen und Gebäudetechnik Fachbereich Technische Gebäudeausrüstung Postfach 10 11 39 40002 Düsseldorf
Inhalt		Seite
Vorbemerkung		2
Einführung		2
1 Anwendungsbereich		2
2 Normative Verweise		3
3 Begriffe		3
4 Abkürzungen		4
5 Neuanlagen		4
5.1 Planung		4
5.2 Installation		19
5.3 Inbetriebnahme		20
5.4 Betrieb und Instandhaltung		21
5.5 Anlagencheck		26
6 Bestandanlagen/Anlagenstörungen		28
6.1 Allgemeine Anmerkungen zu Bestandanlagen		28
6.2 Störungen und Abhilfemaßnahmen		29
Anhang A Hinweise zur pH-Wert-Messung		36
Anhang B Begrifflichkeiten „atmosphärisch“/ „korrosionstechnisch/Flussgeschwindigkeit“ Anlage		37
Anhang C Protokoll – Wassertechnische Untersuchung		38
Anhang D Anlagensteckbrief für Kalt- und Kühlwasserkreisläufe		39
Anhang E Beispiel für Gliederung eines Betriebsbuchs		41
Schriften		42
VDI-Gesellschaft Bauen und Gebäudetechnik (GBG) Fachbereich Technische Gebäudeausrüstung		
VDI-Handbuch Wärme-Melstechnik		

3. WORKING WITH RISYCOR

3.1 ALARM MESSAGES

Predictive maintenance with the Risycor helps to ensure the reliability and service life of the system. If necessary, the Risycor will sound an alarm. The user must then react and rectify the cause of the alarm (see 4.).

We refer to the Risycor manuals, Risycor basics general information texts and Risycor cards information sheets on possible causes of oxygen ingress, www.wikiSIS.org, official guidelines and standards and guides in the industry).

In addition to potential short-term measures, the Risycor also provides the necessary insight into the long-term behaviour of the system, thus exposing hidden defects and other (human) errors. An annual read-out using the free software for data analysis is, therefore, recommended. See below in this section.

Resus also provides free-of-charge assistance with written information, courses, webinars and telephone support in four languages. For in-situ analyses, water-side measurements, observation of potential causes of corrosion and other supportive actions, we have a network of trained and independent specialists who can provide local support for a charge. Alternatively, we can refer you to the maintenance company/technician.

3.2 MEMORY READ-OUT: RESUS DASHBOARDS

Resus offers three different options for reading out the memory of the Risycor, two of which visualise the information from the Risycor as a 'dashboard'. Setting the stored data on a timeline allows the user analyse or identify patterns in the parameters that are captured.

RESUS PC DASHBOARD (RpcDB)

Windows PC and all types of Risycor

The RpcDB is suitable for on-site read-out of all types of Risycor via USB connection to the PC. It provides visual insight into the corrosion behaviour of the system and enables detailed error analysis to be carried out. The RpcDB can also copy the memory of the Risycor to a .csv file.

Previously stored Risycor memory files (also captured with, for example, the hand-held read-out device Risycor) can be opened and analysed again at any time with RpcDB.



Fig.: Local read-out of the Risycor using the Resus PC Dashboard

RESUS CLOUD DASHBOARD (RcIDB)

Internet Cloud and Risycor types CXI & PCXI

The Resus Cloud Dashboard is the online internet version for the read-out of data captured remotely with the Risycor. The data can also be read out into any third-party dashboard (of the boiler manufacturer, building management system manufacturer, monitoring company, etc.) using a custom API. After a free of charge first years use, a cloud subscription must be paid.

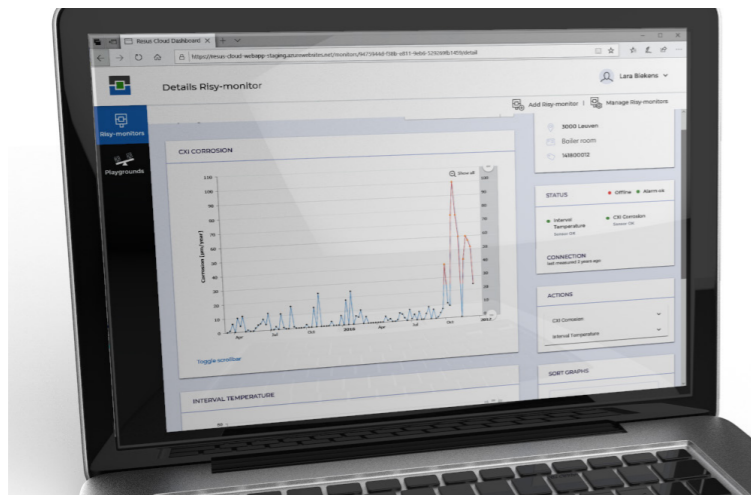

Fig.: Remote read-out of the Risycor using the Resus Cloud Dashboard

BUILDING MANAGEMENT SYSTEMS

The most cost-effective, reliable and straightforward connection: *the volt-free contact*.

The best way to connect the Risycor to a building management system is with the volt-free alarm contact, which is set to 24 $\mu\text{m}/\text{yr}$ (YCR) as standard ex works. The user can change this value using the Resus PC Dashboard.

It must be borne in mind that a high threshold value offers reduced certainty. The connection of a Risycor with a view to forwarding real-time data to a building management system is not possible (see TT10).

See also 3.4 Connecting to a building management system.

3.3 INTERPRETING THE MEASUREMENTS

If the default value of YCR = 24 $\mu\text{m}/\text{year}$ is exceeded, the Risycor will emit an alarm (visually + volt-free contact)

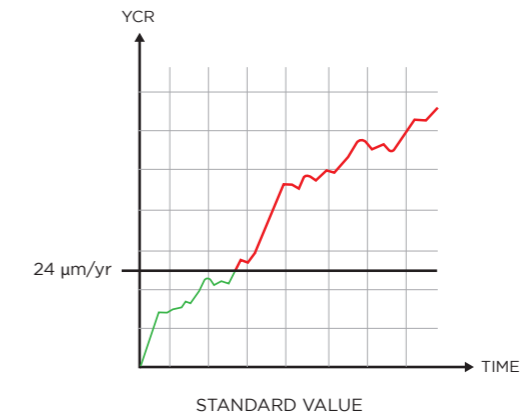

Fig.: Read-out with default threshold value

The threshold value can always be set to a higher value, which offers less certainty. It can also be set to a lower value if it can be determined that, over the long term, the corrosion rate has 'always' been low. Doing this will improve sensitivity to corrosion peaks.

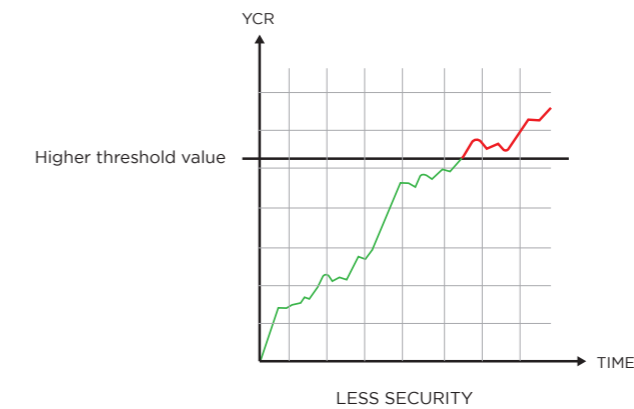

Fig.: Read-out with increased threshold value

A corrosion alarm is NEVER urgent.

3.4 CONNECTING TO A BUILDING MANAGEMENT SYSTEM

3.4.1 LOW OR HIGH ALARM

The default alarm of the Risycor is a 'low' (or non-critical) alarm. This alarm is to warn you that the corrosion rate YCR is currently above the set threshold value. The higher the corrosion intensity and the longer the duration or the higher the frequency, the greater the likelihood of corrosion damage. A one-off corrosion peak (e.g. after emptying and refilling) is not a threat to the service life of the system. But, if the YCR is often above the threshold value, or remains above it for a prolonged period of time, the likelihood of corrosion damage will increase, which increases the chance of eventual corrosion failure.

The alarm level will become 'high' (or critical) if any of the following conditions is satisfied:

- There are more than seven alarms over seven weeks
- The alarm persists for longer than seven days
- Several Risycors in the same system are in an alarm state simultaneously

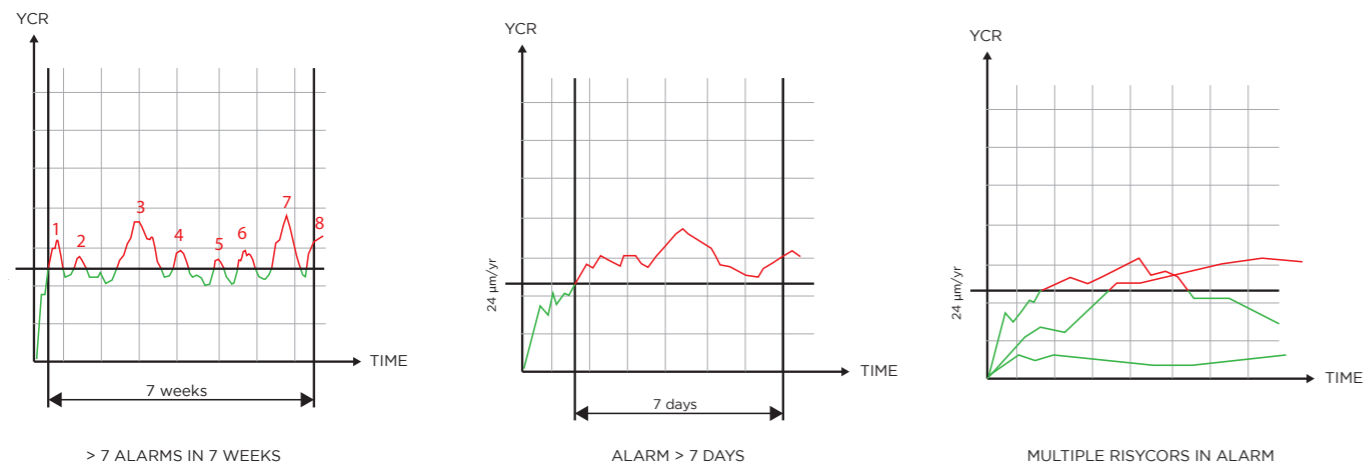

Fig.: Examples of conditions for switching to a 'high' (or critical) alarm

We recommend providing a program line in the building management system – at the input of the corrosion alarm – that provides for the aforementioned conditions.

3.4.2 AVERAGE YEARLY CORROSION RATE AYCR

The average yearly corrosion rate AYCR is also a good indicator of the likelihood of corrosion damage and/or corrosion failure in the medium to long term.

Average yearly corrosion rate (AYCR)		
< 7 $\mu\text{m}/\text{yr}$	7 - 21 $\mu\text{m}/\text{yr}$	$\geq 21 \mu\text{m}/\text{yr}$
Good	Doubtful	Harmful
Result in the long term		
Low likelihood of corrosion damage	Corrosion damage likely	Serious risk of corrosion failure

Remote data read-out

Aside from the standard volt-free contact for alarms (see above) and the data communication options via USB and Internet, Resus offers no direct real-time data communication protocol for building management systems. There are a number of reasons for this:

- A Risycor is not a sensor that can provide an instantaneous measurement signal in the typical sense. Rather, it is an intelligent monitor that uses integrated algorithms to establish a comparative measurement over an average of one week of corrosion history. There is no real-time data signal and 'constructing' one would compromise the truth and lead to misunderstandings.
- The diversity that exists in building management systems requires different data transmission formats and protocols, which would unnecessarily drive up the cost of the Risycor considerably. Moreover, the GUI (user interface) of the building management system would then need to be programmed on a case-by-case basis by the integrator or manufacturer of the building management system.
- Having real-time information about the corrosion values of your system offers no added value or ease of use, or any other benefit. The integrated logic of a Risycor ensures prompt notification in the event that something goes wrong – via the volt-free contact.

An annual overview of the average yearly corrosion rate AYCR and the graphical depiction of changes to the YCR provide the requisite insight.

3.5 OTHER FORMS OF REMOTE SIGNALLING

If no building management system is available, the user may not be notified of an alarm on the Risycor.

The volt-free contact can be used to switch a flashing light, sound horn, SMS module, gas detector, or it can be integrated in the safety circuit of the heat/cold generator.

3.6 ADDITIONAL BENEFIT: TEMPERATURE MONITORING

Monitoring of return temperatures to track the condensation behaviour of the boiler or the efficiency of heat pumps.

The Risycor also measures and logs temperatures. When planning the Risycor according to the scenarios above, the Risycor should always be positioned in the return of the circuit, of the appliance or of the system as a whole. This offers the additional benefit of temperature logging, allowing the user to assess the hydraulic adjustment of the system.

Keep in mind that in the event of a hydraulic imbalance, the return temperature may be higher than anticipated because the flow rate being returned by one or multiple circuits is too high. This in turn can cause condensing boilers to stop condensing or heat pumps to have too low a COP, as the return temperature being provided is too high.

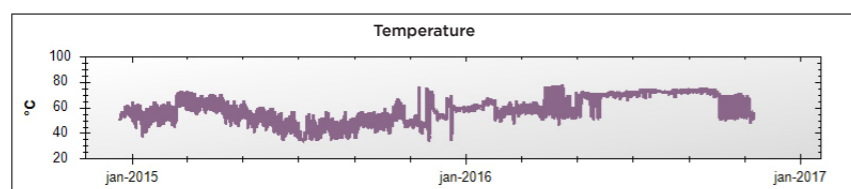

4. CAUSES OF CORROSION DAMAGE AND FAILURE

4.1 RISYBASICS

are information texts that outline a (sometimes complex) technical topic in simple terms.

RIBA 01 - De-oxygenated water

Describes water in a heating or cooling system that now contains almost no dissolved oxygen, has low conductivity and the correct pH.

RIBA 02 - Expansion vessels, expansion systems and pressure maintenance

Open, closed, automatic expansion or pressure maintenance system – the most misunderstood concept in the entire world of heating systems and (almost) always the cause of corrosion problems.

RIBA 03 - Venting, air separation and deaeration

A central heating or cooled water system does not contain air, only nitrogen. Vents, air separators or deaerators cannot prevent corrosion from occurring.

RIBA 04 - Physical water treatment

Softening, demineralisation and other methods of physical water treatment.

RIBA 05 - Forms of corrosion and corrosion occurrence in closed heating and cooling systems

In view of the complexity of corrosion, most heating engineers quickly give up on the problem. But corrosion in closed heating and cooling systems is largely a matter of physics rather than chemistry.

RIBA 06 - Measuring and monitoring corrosion

We compare the different options and explain the advantages and disadvantages.

RIBA 07 - Chemical water treatment, inhibitors and glycol

Chemical water treatment is rarely necessary and is often used where it is not needed.

Moreover, the cure is often worse than the disease.

RIBA 08 - Old, failing and ailing systems

The renovation of older systems sometimes poses specific problems relating to historical corrosion. We look at what should be done, and what shouldn't.

4.2. RISYCARDS

RICA 01 - Automatic air vents

An automatic air vent that suddenly becomes an 'aerator' turns immediately into one of the biggest causes of corrosion !

Although almost everyone thinks that automatic air vents can prevent corrosion (which is hardly the case), in practice it turns out that they even allow air (and therefore oxygen) to enter the installation.

The real CAUSE of the problem lies, of course, in the failing pressure maintenance. This makes it the 'Achilles' heel for the life span of the heating installation.

RICA 02 - Accuracy of a pressure gauge and the green zone

A correct reading pressure gauge is very important and often a sore point in practice. Inaccurate pressure gauges, without green zone, or not adjustable, with reading errors provide poor information and cause misunderstandings. The result: troublesome and expensive consequences due to oxygen entry and thus corrosion sludge formation.

RICA 03 - Neutral point

Sometimes installations have a tendency to suck in air, again and again, while in theory this should not be possible, and apparently everything is in order (see our Risycards and Risybasics).

This is often caused by an incorrectly positioned neutral point, causing the circulation pump to create negative pressure, with the expensive and troublesome consequences of unwanted oxygen entry and thus corrosion (sludge formation).

RICA 04 - Failed Air Inlet Barrier in Pressure Step or Vacuum Degassing

Pressure step or vacuum degassing becomes a massive cause of corrosion if the air inlet barrier fails. This is a non-return valve that must prevent air (and therefore also oxygen) from entering the installation. Depending on whether it concerns vacuum degassing or atmospheric pressure step degassing in combination expansion systems, the amount of oxygen entering can differ greatly.

RICA 05 - Constant pressure expansion systems and the danger of oxygen permeable bladders

The constant pressure expansion system is a risk component due to the danger of an oxygen permeable bladder.

The bladder in the expansion vessel separates the oxygen-depleted system water ("de-oxygenated water") from the oxygen in the compressed air cushion (compressor system) or atmospheric air (pump system). This barrier is of the utmost importance to prevent oxygen entering the system and thus causing corrosion. Most common are butyl rubber (IIR) bladders which have the best resistance to permeation of all commercial rubbers. EPDM is also sometimes used, but has an oxygen permeability approx. 17x higher than that of butyl.

RICA 06 - Breakdown of indirect potable hot water heater

In the event of a leak of the heat exchanger that heats the hot water (PWH) oxygen-rich potable water can enter the heating circuit. This problem may go unnoticed for a long time, with catastrophic consequences in terms of corrosion and possible scale formation.

RICA 07 - Oxygen diffusion through plastics

Most plastics and rubbers are waterproof, but not gastight. Despite the fact that the installation is pressurised relative to the atmosphere, oxygen can still enter due to the difference in partial pressure.

RICA 08 - Explanation constant pressure pressurisation - content indication

The constant pressure expansion system is a risk component due to the frequent misinterpretation of the system pressure on the pressure gauge.

RICA 09 - CI-open systems

Although these systems are marketed as closed systems (which they apparently are), they still cause serious oxygen entry, often resulting in massive corrosion.

In RICA 05 the importance of an oxygen diffusion tight bladder is explained, RICA 09 looks at alternative systems that do not use a bladder.

RICA 10 - Pre-pressure

The incorrect gas fill pressure (pre-pressure) is often the cause of corrosion damage, especially in connection with automatic air vents (see RICA 01).

Too high a pre-pressure is just as wrong as too low, and even a correct pre-pressure can quickly become too low due to pre-pressure loss.

The loss of pre-pressure is often compensated for by unnecessarily adding water instead of correcting the gas fill pressure. In practice, it is by far the most common cause of corrosion damage.



Fig.: Risycard brochures

5. ABOUT RISYCOR

5.1 OPERATING PRINCIPLE

The Risycor works according to a patented measuring system based on the Hall effect. It carries out a direct, comparative measurement of the loss of mass of an iron coupon at the tip of the measuring probe (99.99% Fe) and is thus known as the 'electronic coupon method'. The measuring principle is highly accurate, easy to use and insensitive to pH, conductivity or other parameters of water quality. An integrated temperature sensor ensures adequate temperature compensation.

With the principle of comparative measurements, it takes around a week for the Risycor to capture sufficient data to calculate a corrosion rate, which means that it is not possible to provide an instant measurement signal. This poses no problem, as corrosion is an intrinsically slow process. The response speed of the measuring principle is adjusted to changes in the corrosion rate, e.g. through topping up or taking in air at negative pressure, which are identified within 24 hours.

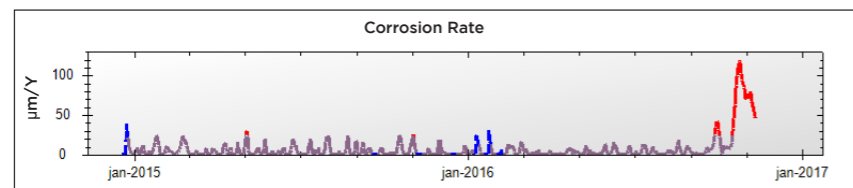

Fig.: The Risycor detects all possible causes of corrosion problems. In the case above, a sticking valve of a pressure-step degasser was the cause of the problem. Instead of degassing, the appliance took in large quantities of air to the CH system, leading to a major peak in corrosion.

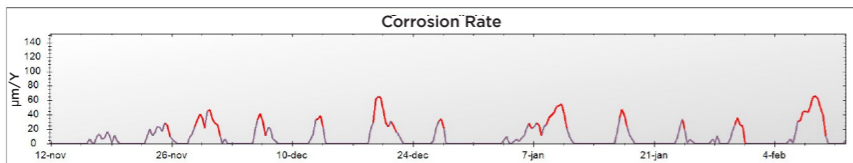

Fig.: In the example above, the corrosion peaks resulting from the intake of air were caused by a weekend reduction in temperature with inadequate pressure maintenance.

Also see TT17 for more information.

5.2 SERVICE LIFE

How long the iron coupon at the tip of the measurement probe will last depends on the average yearly corrosion rate. For a sensible balance between service life and resolution/measurement accuracy, the coupon is 50 µm thick. In a high-quality system, the average yearly corrosion rate will be less than a few microns per year, giving the probe a lengthy service life. Please see the table in 3.4 for an overview of the average yearly corrosion rate.

5.3 LIMITATIONS

The Risycor measures the corrosion rate of the iron coupon at the tip of the probe. This physical, comparative measurement has no limitations, although the conditions in the system may mean that the measurement is not always representative.

5.3.1 INHIBITORS AND GLYCOL

The measuring principle of the Risycor is not influenced by the chemical composition of the system water, inhibitors or glycol. However, the coupon may be partially or fully shielded with a protective film (photo), a typical problem in chemical water treatment, so the measurement may no longer be representative. In heating and cooling systems, glycol usually contains inhibitors.

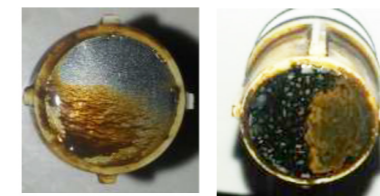

Fig.: Coupons partially shielded by an inhibiting film

Experience shows that the average measurement with Risycor is still sufficiently reliable.

In highly critical systems, triangulation (at least two Risycors in the same place) can further reduce the risk of incorrect measurements.

5.3.2 EARLY INSTALLATION OF THE PROBE, LATER INSTALLATION OF THE LOGGER

Experience suggests that in practice hydraulic components are often installed earlier than their corresponding electronics. A system may be flushed and filled, for example, and may start to corrode, while the logger associated with the Risycor is only installed later on.

As a consequence, part of the coupon may already have corroded before the electronic measurements can detect it. This will not adversely affect the measuring principle of the Risycor, but it will reduce its service life. The read-out from the Risycor thus allows the remaining thickness of the coupon to be measured 'live'.

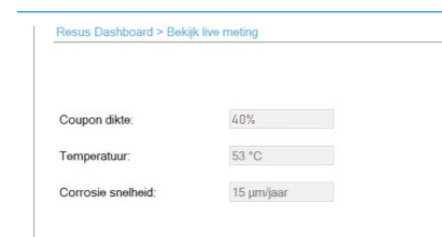

Fig.: Remaining coupon thickness

5.3.3 IN THE RETURN

The measuring principle of the Risycor is sensitive to rapidly and highly fluctuating temperatures as the permeability of the coupon for the eddy currents generated by the Hall effect is heavily influenced by temperature. By installing Risycor in the return line of the system rapid changes in temperature at the Risycor are unlikely. In the unlikely event of an excessively rapid change in temperature at the Risycor, the Risycor will recognise it and add an error code to the measurement to enable the user to identify the cause of the (potentially) unreliable measurement.

5.4 REPRESENTATIVENESS

Oxygen is highly reactive with steel, which means that the rate at which oxygen can be consumed/broken down during the corrosion process of a system is accordingly high. At the same time, the distance between the point of oxygen ingress and the Risycor is seldom more than a few tens of metres, so the dwell time that is available between the ingress of oxygen and measurement by the Risycor tends to be very short. This means that the corrosion rate measurement by a Risycor is sufficiently representative in normal systems.

In very large systems (CHP or district heating systems), the dwell time between the point of oxygen ingress and the measurement point can be much longer,

which can lead to the dissolved oxygen being largely broken down in many kilometres of pipe before it reaches the Risycor. Nevertheless, measurements in the return of district heating grids often still provide relevant and usable information (see TT34).

5.5 CURATIVE USE IN PROBLEM SYSTEMS

Although the Risycor is not intended for use in 'problem installations' (you wouldn't install a smoke detector when there is already a fire), it can be useful for providing evidence of the cause or of the intensity of an oxygen ingress problem. Once the cause has been identified and rectified, the fall in the Risycor's corrosion curve will clearly illustrate that the problem has been rectified.

By fitting two Risycors, for example, one on the inlet and one on the outlet of a risk circuit or component, you can demonstrate whether there is oxygen ingress at that location (the curves from both Risycors can be conveniently compared in the Resus PC Dashboards).

The Risycor+ type PCXI, which logs system pressure alongside interval temperature and corrosion rate, is also a useful aid for problem diagnosis. In the future, our range will be complemented by RISYLOG (detailed diagnostics for problematic systems through measurement of multiple parameters) and RISYPILOT (automated troubleshooting).

5.6 TROUBLESHOOTING

The Risycor uses a volt-free contact to report a fault if the coupon has reached the end of its life or the corrosion rate is excessively high. The 'ALARM IGNORE' function disables the alarm for a period of three days. In that case, the Risycor will not emit an alarm for three days, although the alarm status may still be active. A corrosion alarm indicates that the corrosion rate has exceeded the pre-set threshold value at that specific moment in time. The damage that the system is suffering as result will depend on the corrosion rate value, the frequency and/or the duration of the alarm, see 1.2 and 3.

The causes of corrosion alarms are outlined in 4.

5.7 PRODUCTS

5.7.1 X-FAMILY: UNIVERSAL MOUNTING

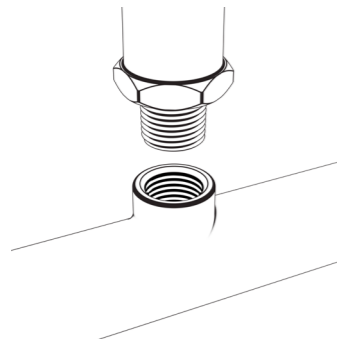

Risycor CX2-fix set

Risycor CX1-fix set

Risycor PCX1-fix set

Risyttest TXV-fix set

SYSTEM			
Heating systems	✓	✓	✓
Cooling systems	✓	✓	✓
INSTALLATION			
Installation in 1/2" female thread	✓	✓	✓
Replaceable under pressure	✓	✓	✓
FUNCTIONS			
Corrosion rate (measurement and logging)	✓	✓	✓
Temperature (measurement and logging)	✓	✓	✓
System pressure (measurement and logging)			✓
Alarm function LED	✓	✓	✓
Alarm function, volt-free contact	✓	✓	✓
READ-OUT			
Visual inspection	✓	✓	✓
Memory can be read out locally via USB	✓	✓	✓
Memory can be read out remotely via the internet		✓	✓

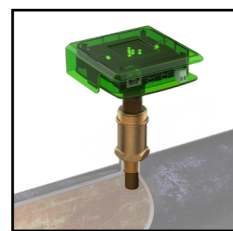
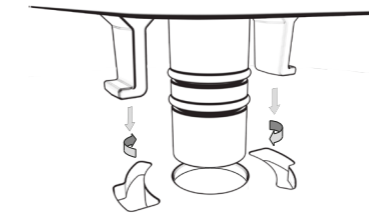

Fig.: Risycor (P)CX-fix set series



Fig.: Risycor TXV-fix set

5.7.2 B-FAMILY: BAYONET MOUNTING



Risycor CBU-fix set (OEM)

Risycor CBU-Zerofix set

SYSTEM		
Heating systems	✓	✓
Cooling systems		
INSTALLATION		
Installation in equipment that can be isolated (boiler, filter, etc.)	✓	
Installation between isolation valves	✓	
Installation with a lock shield valve fitting (= included)		✓
Replaceable under pressure		✓
FUNCTIONS		
Corrosion rate (measurement and logging)	✓	✓
Temperature (measurement and logging)	✓	✓
Alarm function LED	✓	✓
Alarm function, volt-free contact	✓	✓
READ-OUT		
Visual inspection	✓	✓
Memory can be read out locally via USB	✓	✓

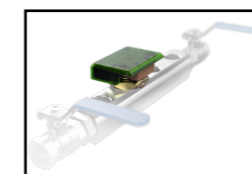

Fig.: Risycor CBU-fix set

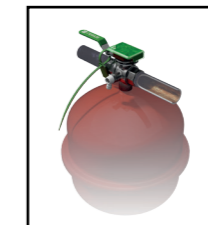

Fig.: Risycor CBU-Zerofix set



Resus nv
Bredabaan 839
B-2170 MERKSEM (Antwerp)
Belgium

t +32 3 640 33 91
f +32 3 640 33 93

www.resus.eu